

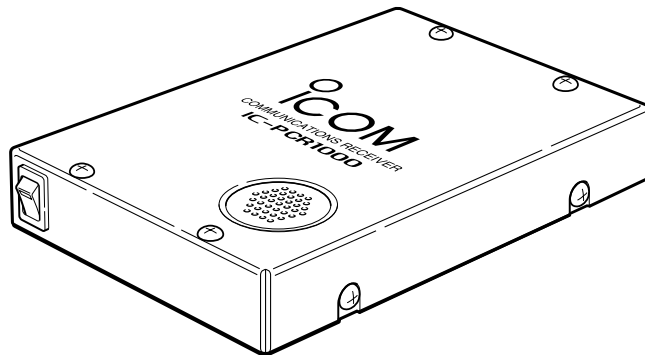

INSTRUCTION MANUAL

COMMUNICATIONS RECEIVER FOR COMPUTER **IC-PCR1000**

This device complies with Part 15 of the FCC Rules. Operation is subject to the following two conditions: (1) This device may not cause harmful interference, and (2) this device must accept any interference received, including interference that may cause undesired operation.



Icom Inc.

IMPORTANT

READ ALL INSTRUCTIONS and on-line help carefully and completely before using the receiver.

SAVE THIS INSTRUCTION MANUAL — This instruction manual contains important operating instructions for the **IC-PCR1000 COMMUNICATIONS RECEIVER FOR COMPUTER**.

USE antenna(s), such as a well-matched 50 Ω antenna and feedline. For radio communications, the antenna is of critical importance, along with sensitivity.

SYSTEM REQUIREMENTS

- IBM PC compatible computer
- An RS-232C serial port (38400 bps or faster)
- Microsoft® Windows® 95 or Microsoft® Windows® 3.1 with appropriate DOS
- Intel i486DX4 processor or faster (Pentium® 100 MHz or faster recommended)
- At least 16 MB RAM
- At least 10 MB of hard disk space
- 640 X 480 pixel display (800 X 600 pixel display recommended)

FEATURES

•USER-SELECTABLE INTERFACE

Users can choose from 3 different operating screens depending on their ability level and preference.

•WIDE FREQUENCY RANGE, MULTI-MODE RECEIVE

The IC-PCR1000 has a wide frequency coverage from 0.5 MHz to 1300 MHz* with all mode receive capability.

*Some frequency ranges are restricted depending on version.

•IF SHIFT

The IF shift function is effective in SSB mode for reducing interference from nearby signals. It does so by electronically shifting the passband of the IF filter.

•REAL-TIME BANDSCOPE FUNCTION

The real-time bandscope function makes it easy to find busy frequencies and also easy to observe receive frequency band conditions. The maximum band width is ± 200 kHz.

**•NOISE BLANKER •VSC (Voice Scan Control) FUNCTION
•S-METER SQUELCH •HIGH PERFORMANCE PLL
CIRCUIT •A VARIETY OF TUNING STEPS •A VARIETY OF
SCANS •DIGITAL AFC CIRCUIT**



Versions of the IC-PCR1000 which display "CE" on the serial number seal, comply with the essential requirements of the 89/336/EEC directive for Electromagnetic Compatibility.

CAUTIONS

⚠ WARNING! NEVER connect the receiver to an AC outlet. This may pose a fire hazard or result in an electric shock.

NEVER connect other than the specified AC adapter to the receiver. This connection will ruin the receiver.

NEVER connect the receiver to a power source of more than 16 V DC such as a 24 V battery. This connection will ruin the receiver.

NEVER allow children to touch the receiver.

NEVER expose the receiver to rain, snow or any liquids.

DO NOT use or place the receiver in areas with temperatures below 0°C (+32°F) or above +50°C (+122°F) or, in areas subject to direct sunlight.

AVOID placing the receiver in excessively dusty environments.

AVOID the use of chemical agents such as benzine or alcohol when cleaning, as they damage the receiver surfaces.

IBM is registered trademark of International Business Machines Corporation in the U.S.A. and other countries. Microsoft® and Windows® are registered trademarks of Microsoft Corporation in the U.S.A and other countries. Screen shots produced with permission from Microsoft Corporation. All other products or brands are registered trademarks or trademarks of their respective holders.

For U.S.A. only (FCC information)

CAUTION: Changes or modifications to this receiver, not expressly approved by Icom Inc., could void your authority to operate this receiver under FCC regulations.

Class B digital device users

This equipment has been tested and found to comply with the limits for a Class B digital device, pursuant to Part 15 of the FCC Rules. These limits are designed to provide reasonable protection against harmful interference in a residential installation. This equipment generates, uses and can radiate radio frequency energy and, if not installed and used in accordance with the instructions, may cause harmful interference to radio communications. However, there is no guarantee that interference will not occur in a particular installation. If this equipment does cause harmful interference to radio or television reception, which can be determined by turning the equipment off and on, the user is encouraged to try to correct the interference by one or more of the following measures:

- Reorient or relocate the receiving antenna.
- Increase the separation between the equipment and receiver.
- Connect the equipment into an outlet on a circuit different from that to which the receiver is connected.
- Consult the dealer or an experienced radio/TV technician for help.

For Canada only

Operation is subject to the following two conditions: (1) this device may not cause interference, and (2) this device must accept any interference, including interference that may cause undesired operation of the device.

1

INSTALLATION

■ Hardware installation

Refer to the diagram below for connections.

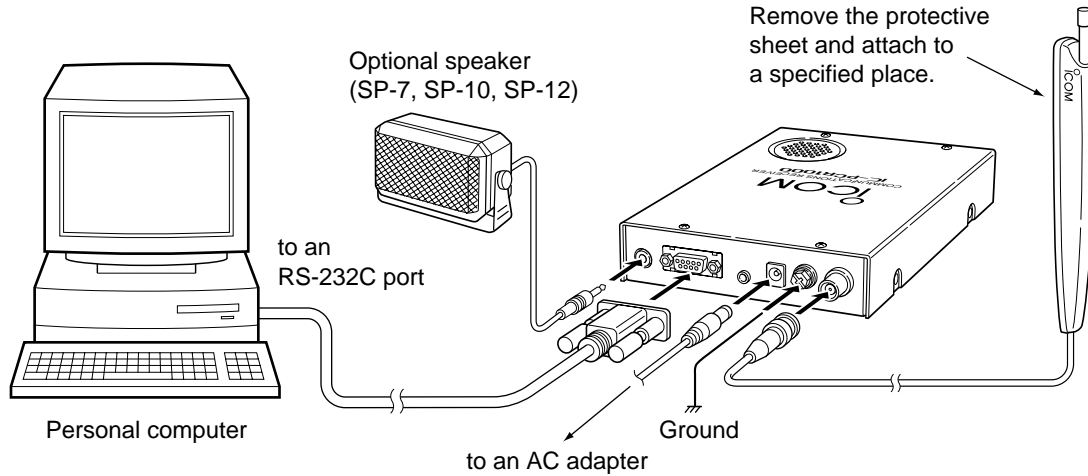

■ Antenna installation

Antennas play a very important role in receiver operation. Connecting a poor quality antenna to the IC-PCR1000 will result in less than optimum performance.

Select antenna(s), such as a well-matched 50 Ω antenna and feedline. 1.5:1 of Voltage Standing Wave Ratio (VSWR) is recommended for a desired band. Of course, the antenna line should be a coaxial cable.

CAUTION: Protect your receiver from lightning by using a lightning arrestor.

NOTE: The supplied antenna is a simple plain antenna which may not obtain indicated specifications. To obtain maximum performance from the IC-PCR1000, you must purchase an external wide band antenna such as an optional Icom AH-7000 (25–1300 MHz), etc.

Contact your nearest Icom Dealer or Service Center for regarding optimum antenna locations.

The antenna connector type is BNC, so an adapter may be necessary to connect an optional antenna.

■ Grounding

WARNING: NEVER use a gas pipe or electrical conduit pipe for grounding.

To prevent accidents involving electricity and interference from computers, ground the receiver through the GROUND terminal on the rear panel.

For best results, connect a heavy gauge cable to a water pipe or long, earth-sunk copper rod. Make the distance between the [GND] terminal and ground as short as possible.

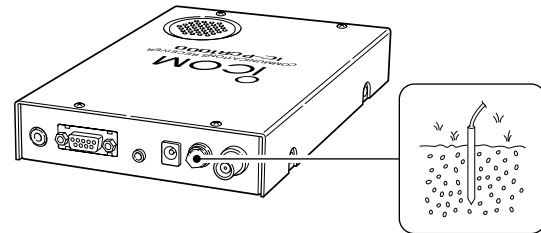

1 INSTALLATION

■ AF output level selection

The received audio can be input into your computer via the sound card.

Before inputting the received audio into the [LINE IN] connector (connector name depends on your sound card), the output level of the [EXT-SP] must be set properly. Perform as follows:

- ① Remove the 8 screws from the cover as shown below. Open the cover.

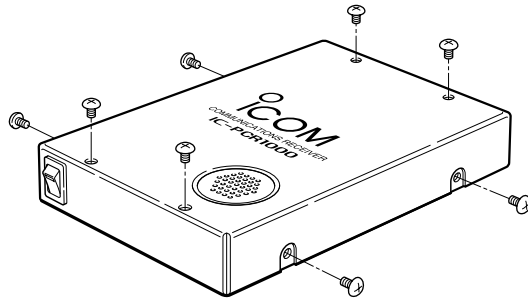

- ② Select the output level as shown below.
 - "SPEAKER" for internal speaker.
 - "PHONES" for PC sound card or headphones.

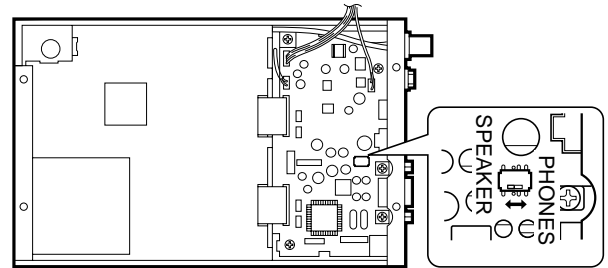

- ③ Replace the 8 screws and cover.
- ④ Connect an appropriate cable between IC-PCR1000 and PC.
 - Plug for [EXT-SP] is supplied with the receiver.

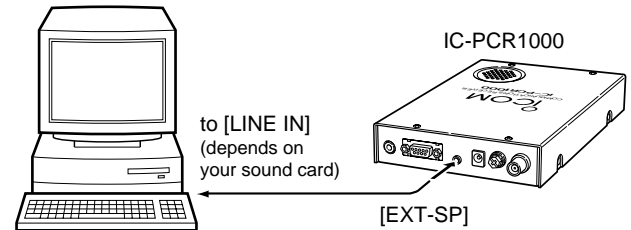

■ TNC connection

The IC-PCR1000 can receive 9600 bps packet communication (AFSK). Connect the TNC (Terminal Node Controller) as follows.

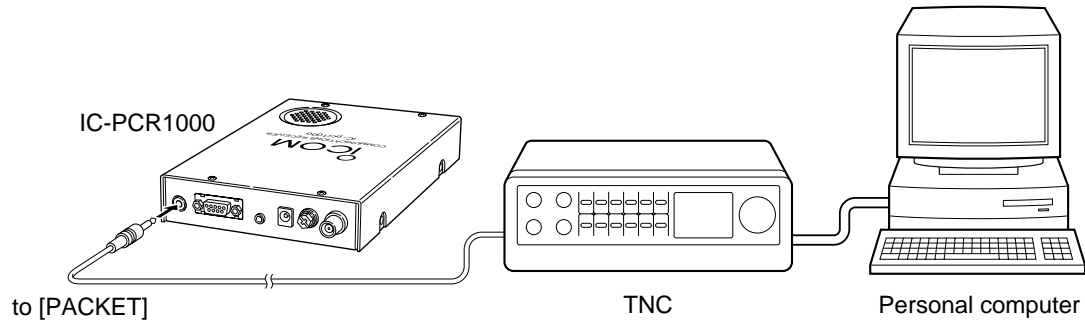

1 INSTALLATION

■ Software installation

 **NOTE:** Before using the program, make a backup copy of the original disk. After making a backup copy, keep the original disk in a safe place.

◇ Windows 95

- ① Boot up Windows.
 - Quit all applications when windows is running.
- ② Insert the backup disk 1 into the appropriate floppy drive.
- ③ Select 'Run' from the [Start] menu.
- ④ Type the setup program name with full path name, then press the [Enter] key. (A:\SETUP [Enter])
- ⑤ Follow the prompts.
- ⑥ Program group 'IC-PCR1000' appears in the 'Programs' folder of the [Start] menu.

◇ Windows 3.1

- ① Boot up Windows.
 - Quit all applications when windows is running.
- ② Insert the backup disk 1 into the appropriate floppy drive.
- ③ Select 'Run' from the File menu of the Program Manager.
- ④ Type the setup program name with full path name, then press the [Enter] key. (A:\SETUP [Enter])
- ⑤ Follow the prompts.
- ⑥ Program group 'IC-PCR1000' appears in the Program Manager.

◇ On-line help information

See the on-line help for software usage.

- ① Click the [Contents] in the [Help] menu to bring up the on-line help.
- ② Click the desired information you want to know.

◇ Software update information

Software update information will be available at the Icom America home page:

<http://www.icomamerica.com/>

■ Serial port setting

Select the RS-232C serial port correctly if the title bar displays "COM port trouble?".

- ① Before launching the program make sure the IC-PCR1000 interface unit power is turned on (the LED lights when power is on).
- ② Launch the IC-PCR1000 software.
- ③ Click the [POWER] button in the tool bar to temporarily pause the program.
- ④ Click the [PORT] button to bring up the [RS-232C PORT Number] dialog box.
- ⑤ Click the desired port COM number to choose it.
- ⑥ Click the [OK] button.

■ Component screen

See the on-line help for more information.

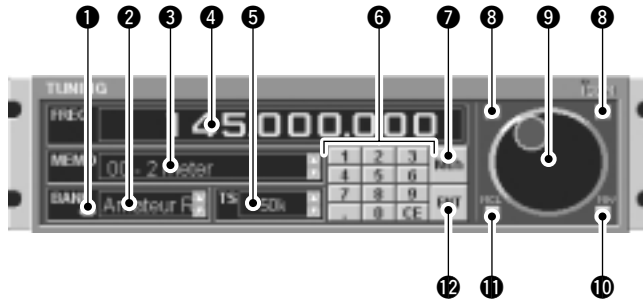

① BANK (memory bank) button

Used to change the memory bank number indication and memory bank name indication when using the component screen.

② BANK (memory bank) indicator

Indicates the memory bank (and its name if it has one) being received.

③ MEMO (memory) indicator

Indicates the memory channel (and its name if it has one) being received.

④ FREQ (frequency) indication

Indicates the receive frequency and data as it is being input such as memory channel numbers, etc.

⑤ TS (tuning step) indicator

This is the frequency increment used when selecting a frequency using the [Main dial] and when searching for signals using a scan function.

⑥ Numeral buttons ([0] to [9])

Used to input a receive frequency or memory channel directly.

⑦ Mch (memory channel) button

Used to set the numeral buttons for memory channel input.

⑧ Tuning step buttons

Used to change the tuning step.

⑨ Main dial

Used to select a receive frequency.

⑩ MW (memory write) button

Writes the current receive frequency into a memory channel.

⑪ MCL (memory clear) button

Used to clear the contents of unneeded memory channels.

⑫ ENT (enter) button

Used to set the numeral buttons for frequency input.

2 PANEL DESCRIPTION

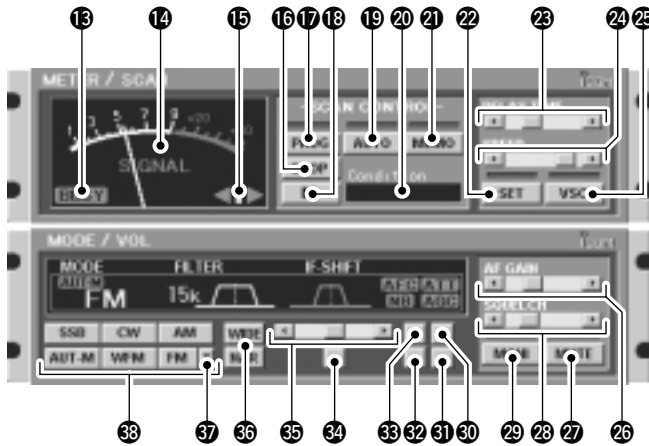

13 BUSY indicator

Appears when receiving a signal or when signal noise opens the squelch.

14 Signal meter

Indicates the receive signal strength. Also indicates the S-meter squelch receive level set via the [SQUELCH] scroll bar.

15 Center indicators

Indicate the tuning level when selecting the 6 kHz or 15 kHz IF filter in FM mode.

16 STOP button

Cancels scan operation.

17 PROG (program scan) button

Used to start/stop program scan. The indicator lamp lights during scan and Program SCAN appears in the Condition indicator window.

18 II (scan pause) button

Used to pause/resume a scan. When a scan is paused, Pause appears in the Condition indicator window.

19 AUTO (auto memory write scan) button

Used to start/stop auto memory write scan. The indicator lamp lights during scan and Auto MW SCAN appears in the Condition indicator window.

20 Condition indicator window

Indicates the scan function operating condition. When scan temporarily pauses to receive a signal Busy Stop appears.

21 MEMO (memory scan) button

Used to start/stop any of the memory scans. The indicator lamp lights during scan and Memory SCAN appears in the Condition indicator window.

22 SET button

Shows/hides the [Setting] dialog box used to adjust settings for scan functions, the band scope function and the automatic mode function.

23 DELAY TIME scroll bar

This sets the period in which a scan pauses after receiving a signal. Moving the knob to the right increases the period; to the left decreases the period.

24 SPEED (scan speed) scroll bar

Sets the speed at which scans search through frequencies/memories for signals. Moving the knob to the right increases the speed; to the left decreases the speed.

25 VSC (Voice Scan Control) button

Turns the voice scan control function on and off. This function detects whether signals are modulated (contain voice or music components, etc.) or not.

26 AF (audio frequency) GAIN scroll bar

Adjusts the audio output.

27 MUTE button

Turns the mute function on and off. Used to temporarily mute audio output.

28 SQUELCH scroll bar

Adjusts the squelch level.

29 MONI (Monitor) button

Turns the monitor function on and off. The monitor function is used to temporarily open the squelch to listen to weak signals.

30 ATT (Attenuator) button

Turns the attenuator on and off.

31 AGC (Automatic Gain Control) button

Turns the AGC function on and off.

32 NB (Noise Blanker) button

Turns the noise blanker function on and off. The noise blanker is used to reduce pulse type noise.

33 AFC (Automatic Frequency Control) button

Turns the AFC function on and off. This function tracks the receive signal when drifting.

34 Center button

After moving a signals' passband position with the [IF-SHIFT] scroll bar, this button returns it to the center position.

35 IF-SHIFT (IF shift) scroll bar

Sets a signals passband position. Moving the knob to the right sets the passband higher, moving the knob to the left sets the passband lower.

36 FILTER (IF filter) buttons

Change the IF filter in use. The [WIDE] button selects a wider filter, the [NAR] button selects a narrower filter.
- Usable IF filters vary according to receive mode.

37 T (Tone squelch) button

Shows/hides the [TONE SQUELCH] dialog box for setting tone squelch tone frequencies.

38 Receive mode buttons

Select a receive mode. Using the [AUT-M] button to select automatic mode also selects a receive mode.

2 PANEL DESCRIPTION

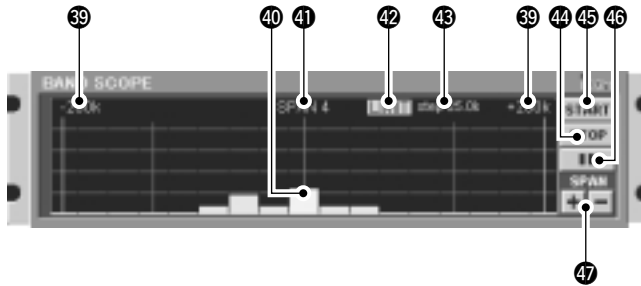

- 39 +200k/-200k (Max. frequency span value) indicators**
Indicate the upper and lower observable frequency limits around a receive frequency.
In the diagram, the upper and lower limits are +200 kHz and -200 kHz.
- 40 Center frequency indicator**
Indicates the center frequency of the frequency span; this is for the currently received frequency.
- 41 Frequency span indication**
Indicates the frequency span selected with the [SPAN+/-] button.

- 42 LIMIT indicator**
Indicates when the tuning step is greater than the automatic sweep step setting.
In the diagram, the tuning step is greater than the automatic sweep step setting and the tuning step (TS) and the sweep step width are not the same.
- 43 Sweep step indicator**
Indicates band scope sweep step.
- 44 STOP button**
Stops the band scope (sweep) function.
- 45 START button**
Starts the band scope (sweep) function which is used to observe signal conditions around the receive frequency.
- 46 II (sweep pause) button**
Pauses/resumes a band scope function sweep.
- 47 SPAN +/- buttons**
Select one of four levels for the band scope frequency span.

■ Radio screen

The radio screen shows 10 memory channel buttons and frequency readout, etc. like a typical stereo tuner—this provides the simplest operation for monitoring your most-listened-to stations, such as AM/FM broadcasting and TV, etc.

See the on-line help for the radio screen details.



■ Communications receiver screen

The communications receiver screen shows S-meter (signal strength) level, a large frequency readout, keypad, etc.—what you would see on the front panel of a typical communications receiver.

See the on-line help for the communications receiver screen details.



- Selectivity :
 - WFM 230 kHz/−6 dB
 - WFM/FM/AM 50 kHz/−6 dB
 - FM/AM 15 kHz/−6 dB
 - FM/AM/SSB/CW 6 kHz/−6 dB
 - AM/SSB/CW 2.8* kHz/−6 dB
- *Software indicates 3 kHz.
- IF shift range : More than ±1.2 kHz
- Max. audio output : 200 mW
(at 10% distortion with an 8 Ω load)
- Antenna connector : BNC (50 Ω)
- RS-232C connector : D-sub 9-pin (female)
- Ext. speaker connector : 3-conductor 3.5 (d) mm (1/8")/
4–8 Ω
- Dimensions (projections not included):
127.5(W)×30(H)×199(D) mm
5(W)×1 3/16(H)×7 27/32(D) in
- Weight : approx. 1 kg; 2 lb 3 oz.

■ Unpacking

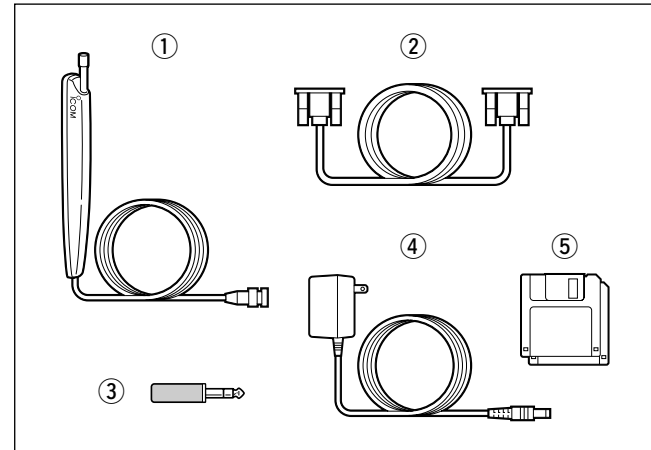

- ① Telescoping antenna 1
- ② RS-232C cable (OPC-743) 1
- ③ External speaker plug 1
- ④ AC adapter (BC-123A/E/V or BM-104E/V)* 1
- ⑤ Software floppy disks 1 set

* For versions which do not come with an AC adapter, a DC power cable and 2 fuses (FGB 2 A) are supplied. An optional AC adapter (BC-123A/E/V or BM-104E/V) is also available.

All stated specifications are subject to change without notice or obligation.

Count on us!

A-5456G-1EX-②
Printed in Japan
© 1997 Icom Inc.

Icom Inc.
6-9-16 Kamihigashi, Hirano-ku, Osaka 547-0002 Japan